

PE7216r / PE7324r

eco PDU

- As part of its NRGence line, ATEN has developed a new generation of green energy power distribution units (eco PDUs) to effectively increase the efficiency of data center power usage. The NRGence PE7216r / PE7234r eco PDUs are intelligent PDUs that contain 16 or 24 AC outlets and are available in various IEC or NEMA socket configurations.

NRGence eco PDUs provide secure, centralized, intelligent, power management (power on, off, cycle) of data center IT equipment (servers, storage systems, KVM switches, network devices, serial data devices, etc.), as well as the ability to monitor the center's health environment via sensors¹.

NRGence eco PDUs offer remote power control combined with real-time power measurement – allowing you to control and monitor the power status of devices attached to the PDUs, either at the PDU device, bank, or outlet level, depending on the model, from practically any location via a TCP/IP connection².

The eco PDU also offers comprehensive power analysis reports which can separate departments and locations, providing precise measurements of current, voltage, power and watt-hour in a real-time display.

In order to manage more outlets from the same single session, the eco PDU also provides daisy chain functionality; up to 5 additional units can be daisy chained. Installation and operation is fast and easy: plugging cables into their appropriate ports and user-friendly browser-based configuration and management is all that is entailed. Since the eco PDU firmware is upgradeable over the Net, you can stay current with the latest functionality improvements simply by downloading updates from our website as they become available.

NRGence eco PDU supports any 3rd party V1, V2, V3 SNMP Manager Software, NRGence eco Sensors (eco PDU Manager Software), and CC2000 Control Center Over the NET software. Eco Sensors provides you with an easy method for managing multiple devices, offering an intuitive and user-friendly Graphical User Interface that allows you to configure a PDU device and monitor power status of the equipment connected to it.

With its advanced security features and ease of operation, the eco PDU is the most convenient, most reliable, and most cost effective way to remotely manage power access for multiple computer installations and allocate power resources in the most efficient way possible.

- * **Note:** 1. Sensors are optional accessories. A sensor-enabled installation is required to generate a more complete energy-efficient data and chart. Higher sensor installation density is helpful to generate more accurate data.
- 2. eco PDUs are primarily designed for access via Intranet; extra network security protection is suggested for Internet access usage.

PE7216rB ECO PDU

Description:	100-240V 20A 0U 16-Outlet PDU
Function:	16-Outlet Metering, 0-Outlet Switching Control & 1-Bank Metering
Input Power Plug:	NEMA 6-20P
Power Capacity:	4.2 kW
Socket Configuration:	IEC 60320 C19 (2) IEC 60320 C13 (14)

Features

Connections

- Supports 10/100Mbit Ethernet, OOB, RS-232, Daisy Chain interface
- Supports TCP/IP, PPP, UDP, HTTP, HTTPS, SSL, STP, DHCP, ARP, NTP, DNS, Telnet, Auto Sense, Ping, SNMP V1,V2&V3, IPv6
- Supports three-level account/password security, IP/MAC filter, 128 bit SSL, RADIUS, TACACS+, LDAP, LDAPS and Active Directory
- Supports CC2000, eco Sensors, Java API, multiple Browsers (IE, Firefox, Chrome, Safari)

Metering

- PDU and outlet level power metering and monitoring
- Environment monitoring – supports external temperature/temperature & humidity sensors for rack temperature and humidity monitoring
- Current, voltage, power, power dissipation, temperature, and humidity metering and threshold level setting

Outlet Switch Control

- Daisy chain with PON In – PON Out port
- Always On

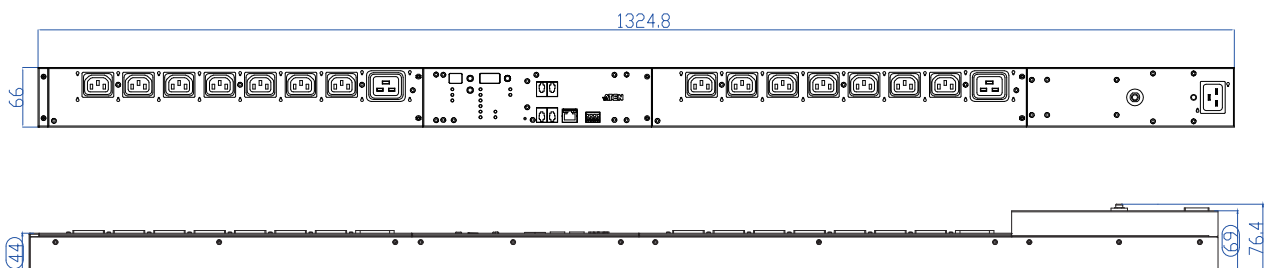
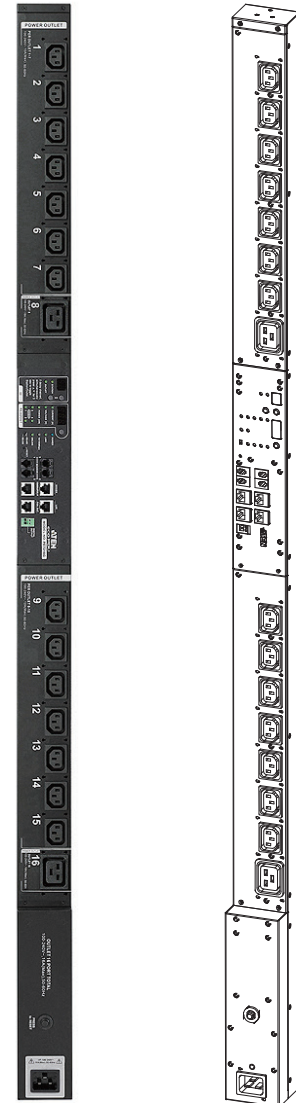

Specifications

Model	PE7216rB
Electrical	
Nominal Input Voltage	100 – 240 VAC
Maximum Input Current	20A Max ; 16A (UL de-rated)
Input Frequency	50-60 Hz
Input Connection	1 x NEMA 6-20P
Input Power	4160 VA(Max) 3328 VA (UL de-rated) Total : 14 x IEC320 C13 + 2 x IEC320 C19
Outlet Type	Bank1-1 : Outlet 1 – 8 ; 7 x C13 + 1 x C19 Bank1-2 : Outlet 9 – 16 ; 7 x C13 + 1 x C19
Nominal Output Voltage	100 – 240 VAC
Maximum Output Current (Outlet)	C13 : 15A (Max) 12A(UL de-rated) C19 : 20A (Max) 16A(UL de-rated)
Maximum Output Current (Bank)	20A(Max) 16A (UL de-rated)
Maximum Output Current (Total)	20A(Max) 16A (UL de-rated)
Breakers	1 x 20A Non-Fuse breaker
Metering	Per Outlet Level Current, Voltage, VA, PF, KWh Monitoring
Outlet Switch	None
Environment Sensor Port	4
Metering Accuracy	Voltage Range: 100VAC ~ 250VAC +/-1% Power Range: 100W ~ 5000W +/- 2% Current Range: 0.1A~1A +/- 0.1A, 1A~20A +/-1%
Mechanical	
Dimension (H x W x D)	132.5 x 6.6 x 4.4 cm
Shipping Dimensions (H x W x D)	142 x 16 x 17 cm
Weight/Shipping Weight	3.7 / 7.7 kg
Power Cord Length	3 m
Environmental	
Temperature (Operating / Storage)	0 – 50°C / -20 – 60°C
Humidity (Operating & Storage)	0 – 80% RH, Non-Condensing
Compliance	
EMC Verification	FCC Part 15 Class A
Safety Verification	cTUVus, TUV-PSE

Package Contents

1. PE7216rB
2. Standard Rack Mount Kit
3. Quick Start Guide
4. CD-ROM (Manual, eco Sensors Software)
5. Power Cord
6. 4 Serial Adapter



Rack Mount Kit

Optional Accessories

Environment Sensors

Part No.	Sensor
EA1140	Temperature
EA1240	Temperature / Humidity
EA1340	Differential Pressure / Temperature

Cable Holders

Part No.	Description
2X-EA07	Lok-U-Plug Cable Holder (10 pcs per pack) Patent Pending!
2X-EA08	Lok-U-Plug Installation Tool (4 pcs per pack)

• Lok-U-Plug Installation



Mounting Kit



Button Mount Kit
(2X-017G)

• Button Mount Installation

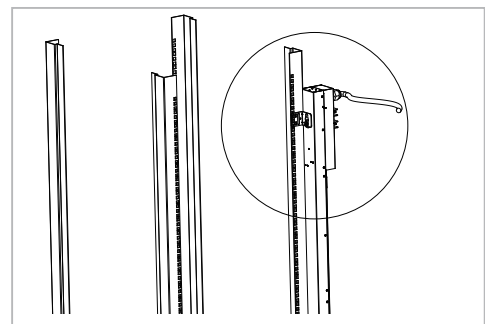

PE7324rB ECO PDU

Description:	100-240V 30A 0U 24-Outlet PDU
Function:	24-Outlet Metering, 0-Outlet Switching Control & 2-Bank Metering
Input Power Plug:	NEMA L6-30P
Power Capacity:	6.2 kW
Socket	IEC 60320 C19 (3)
Configuration:	IEC 60320 C13 (21)

Features

Connections

- Supports 10/100Mbit Ethernet, OOB, RS-232, Daisy Chain interface
- Supports TCP/IP, PPP, UDP, HTTP, HTTPS, SSL, STP, DHCP, ARP, NTP, DNS, Telnet, Auto Sense, Ping, SNMP V1,V2&V3, IPv6
- Supports three-level account/password security, IP/MAC filter, 128 bit SSL, RADIUS, TACACS+, LDAP, LDAPS and Active Directory
- Supports CC2000, eco Sensors, Java API, multiple Browsers (IE, Firefox, Chrome, Safari)

Metering

- PDU and outlet level power metering and monitoring
- Environment monitoring – supports external temperature/temperature & humidity sensors for rack temperature and humidity monitoring
- Current, voltage, power, power dissipation, temperature, and humidity metering and threshold level setting

Outlet Switch Control

- Daisy chain with PON In – PON Out port
- Always On

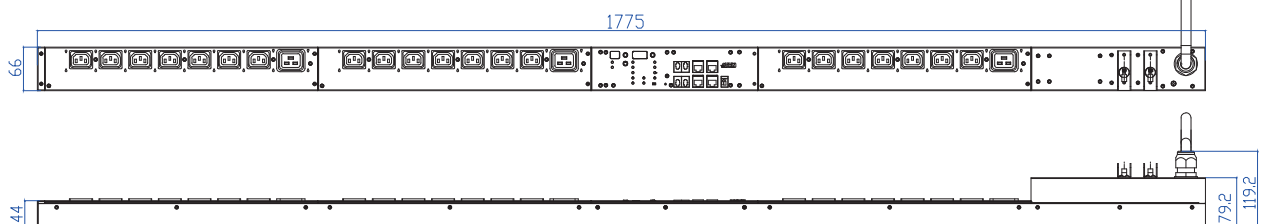
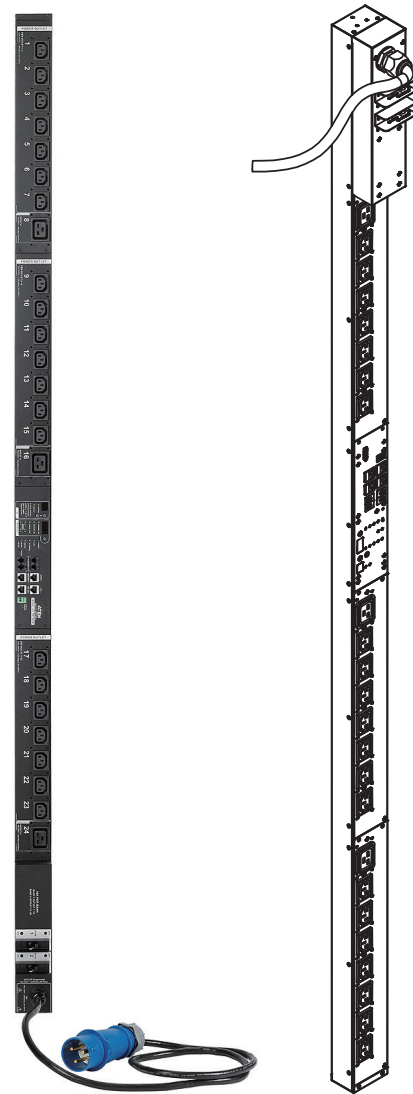

Specifications

Model	PE7324rB
Electrical	
Nominal Input Voltage	100 – 240 VAC
Maximum Input Current	30A Max ; 24A (UL de-rated)
Input Frequency	50-60 Hz
Input Connection	NEMA L6-30P
Input Power	6240 VA(Max) 4992 VA (UL de-rated) Total : 21 x IEC320 C13 + 3 x IEC320 C19
Outlet Type	Bank1-1 : Outlet 1 – 8 ; 7 x C13 + 1 x C19 Bank1-2 : Outlet 9 – 16 ; 7 x C13 + 1 x C19 Bank2 : Outlet 17 – 24 ; 7 x C13 + 1 x C19
Nominal Output Voltage	100 – 240 VAC
Maximum Output Current (Outlet)	C13 : 15A (Max) 12A(UL de-rated)
Maximum Output Current (Bank)	C19 : 15A (Max) 12A(UL de-rated)
Maximum Output Current (Total)	15A(Max) 12A (UL de-rated)
Breakers	30A(Max) 24A (UL de-rated)
Metering	2 x 16A UL489 Breaker Per Outlet Level Current, Voltage, VA, PF, KWh
Outlet Switch	Monitoring
Environment Sensor Port	None
Metering Accuracy	4 Voltage Range: 100VAC ~ 250VAC +/-1% Power Range: 100W ~ 5000W +/- 2% Current Range: 0.1A~1A +/- 0.1A, 1A~20A +/-1%
Mechanical	
Dimension (H x W x D)	177.5 x 6.6 x 4.4 cm
Shipping Dimensions (H x W x D)	189 x 21 x 17 cm
Weight/Shipping Weight	6.5 / 10.5 kg
Power Cord Length	1.6 m
Environmental	
Temperature (Operating / Storage)	0 – 50°C / -20 – 60°C
Humidity (Operating & Storage)	0 – 80% RH, Non-Condensing
Compliance	
EMC Verification	FCC Part 15 Class A
Safety Verification	cTUVus, TUV-PSE

Package Contents

1. PE7324rB
2. Standard Rack Mount Kit
3. Quick Start Guide
4. CD-ROM (Manual, eco Sensors Software)
5. 4 Serial Adapter



Rack Mount Kit

Optional Accessories

Environment Sensors

Part No.	Sensor
EA1140	Temperature
EA1240	Temperature / Humidity
EA1340	Differential Pressure / Temperature

Cable Holders

Part No.	Description
2X-EA07	Lok-U-Plug Cable Holder (10 pcs per pack) Patent Pending!
2X-EA08	Lok-U-Plug Installation Tool (4 pcs per pack)

• Lok-U-Plug Installation



Mounting Kit



Slide Rail Kit
(2X-016G)



Button Mount Kit
(2X-017G)

• Side Mount Installation

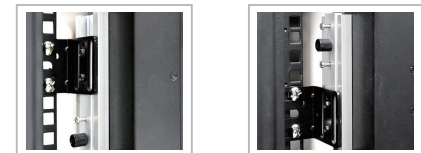

• Button Mount Installation

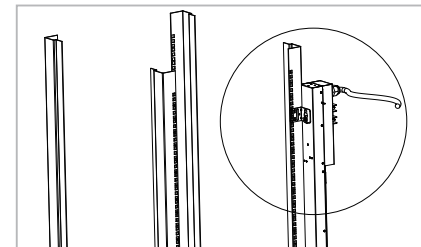

ATEN International Co., Ltd.

3F., No.125, Sec. 2, Datong Rd., Sijhih District., New Taipei City 221, Taiwan
 Phone: 886-2-8692-6789 Fax: 886-2-8692-6767
 www.aten.com E-mail: marketing@aten.com

Printed 11/2013 V2.0



© Copyright 2013 ATEN® International Co., Ltd.
 ATEN and the ATEN logo are trademarks of ATEN International Co., Ltd.
 All rights reserved. All other trademarks are the property of their respective owners.